

User Manual

English

6175 Money Counting Scale



Print version

[Click here](#) to open a printable version of the manual in the selected language.

Table of contents

1. Package contents	04
2. Safescan 6175	05
3. Display and buttons	06
4. First time use	07
4.1. Installation	
4.2. Set region (location of use)	
4.3. Select currency	
5. Counting instructions	10
5.1. Counting coins	
5.2. Counting banknotes	
5.2.1. Too many banknotes on the platform	
5.2.2. Illogicalweight detected	
5.3. Counting old and new versions of the same denomination	
5.4. Counting coin rolls	
5.4.1. Counting coin rolls/bags with automatic coin roll recognition 'AUTO'	
5.4.2. Counting coin rolls / bags that are similar in weight	
5.4.3. Counting/viewing coin rolls/bags per denomination	
5.5. Ending a count	
5.5.1. View current count results	
5.5.2. Clear / Correct count results	
5.5.3. Save / Print* / SET Bank / Add Reference	
5.5.4. Export count results to Safescan MCS	
5.5.5. Start a new count	

6. Menu and operation	24
6.1. General operation	
6.2. Menu structure	
6.3. New count	
6.4. Weighing scale	
6.5. Currency	
6.6. Calibrating coin rolls/bags, banknote bundles, non-cash items, second coin cup	
6.7. Calibrating non-cash items	
6.7.1. Calibrating vouchers	
6.7.2. Calibrating tokens	
6.8. Calibrating a second coin cup	
6.9. Set device	
6.9.1. Submenu - structure	
6.9.2. Time and date setting	
6.10. View saved count results	
6.11. Clear all counts	
<hr/>	
7. Count menu and operation	47
7.1. Opening the count menu	
7.2. Count menu structure	
7.3. Save count	
7.4. Set bank	
7.5. Set a reference number	
7.6. Print	
<hr/>	
8. Troubleshooting	53
<hr/>	
9. Rechargeable battery (Optional accessory)	59
9.1. Installing the Safescan LB-205 rechargeable battery	
9.2. Rechargeable battery status indication	
<hr/>	
10. Updates	60
<hr/>	
11. Safety precautions	61
<hr/>	
12. Optional accessories	63
<hr/>	
13. Specifications	64
<hr/>	

1. Package content

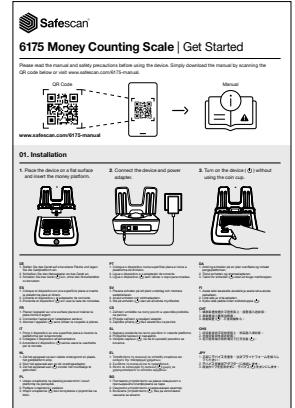

1. Safescan 6175 Money Counting Scale
2. Money platform
3. Coin cup
4. USB / MCS connection cable
5. Power adapter (12V/0.5A, 6 Watt)
6. Get started folder / Safety instructions

2. Safescan 6175

Front

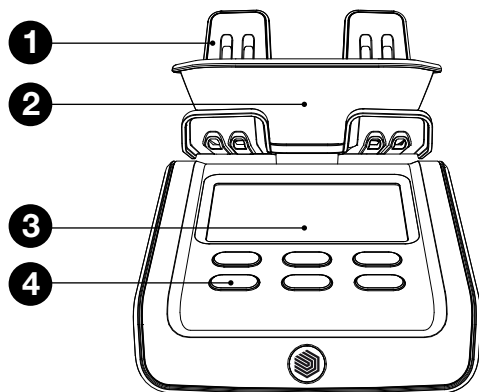

Bottom

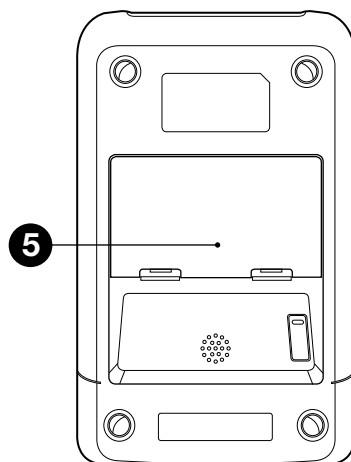

Back

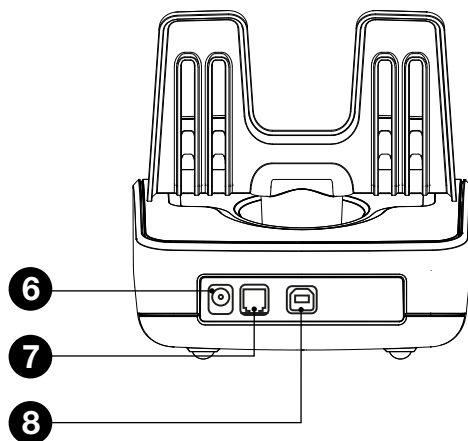

1. Money platform
2. Coin cup
3. LCD display
4. Control keys
5. Battery compartment
6. Power connector
7. Printer connector
8. USB / MCS connection port

3. Display and buttons

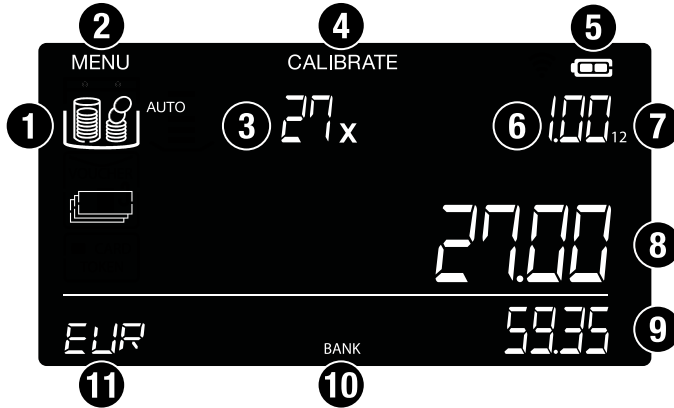

1. Cash value items (coins, banknotes, bundles, non-cash items)
2. Settings menu
3. Quantity
4. Calibration menu
5. Battery level indicator
6. Denomination
7. Denomination version
8. Current value / value on platform
9. Total counted value
10. Active bank feature
11. Currency

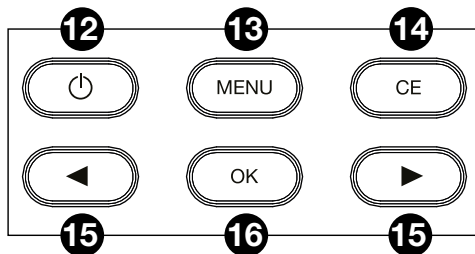

12. Power ON / OFF
13. Open settings menu
14. Clear entry / back
15. Navigation keys
16. Confirm selection / Add value to total

4. First time use

4.1. Installation

1. Place the device on a flat surface and insert the money platform.

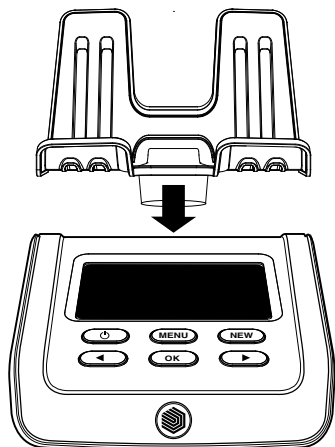

2. Connect the device and power adapter.

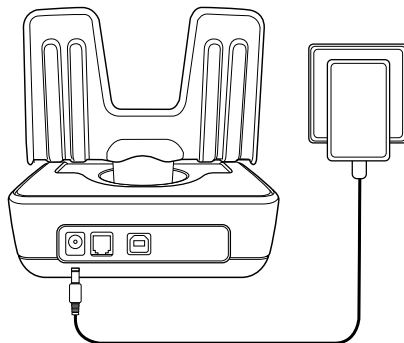

3. Turn on the device (⏻).

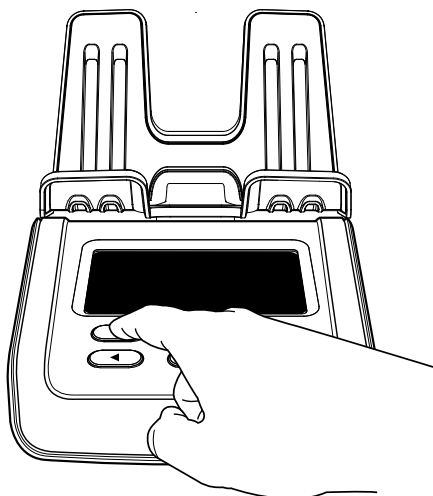

Note: Do not place the coin cup on the money platform when you power on the device!

4.2. Set region (location of use)

1. Once your device is powered on, please select the region / location where it will be used.
2. Use the arrow keys (◀ ▶) to switch between the different available regions (**EUROPE**, **UK**, **USA**, **S-E ASIA** and **AUSTRALIA**).



3. Once you have selected the correct region, press **“OK”**.

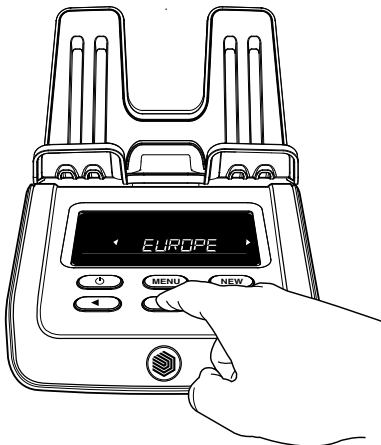

4.3. Select currency

1. Next, use the arrow keys (◀▶) to select your default currency and press “OK” to save your preference.
2. The device will now activate the counting mode so you can start counting, starting with the smallest denomination.

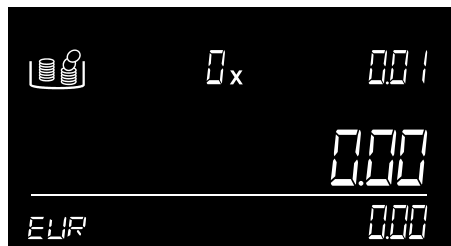
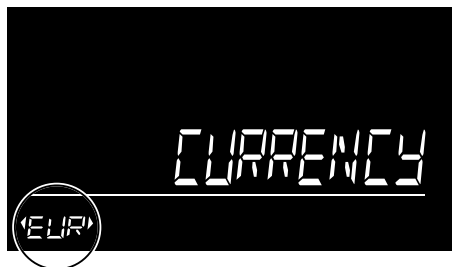

5. Counting instructions

Note: Count one denomination at a time. For efficient counting, please make sure that coins and banknotes have been sorted beforehand. Always use the coin cup when counting coins.

5.1. Counting coins

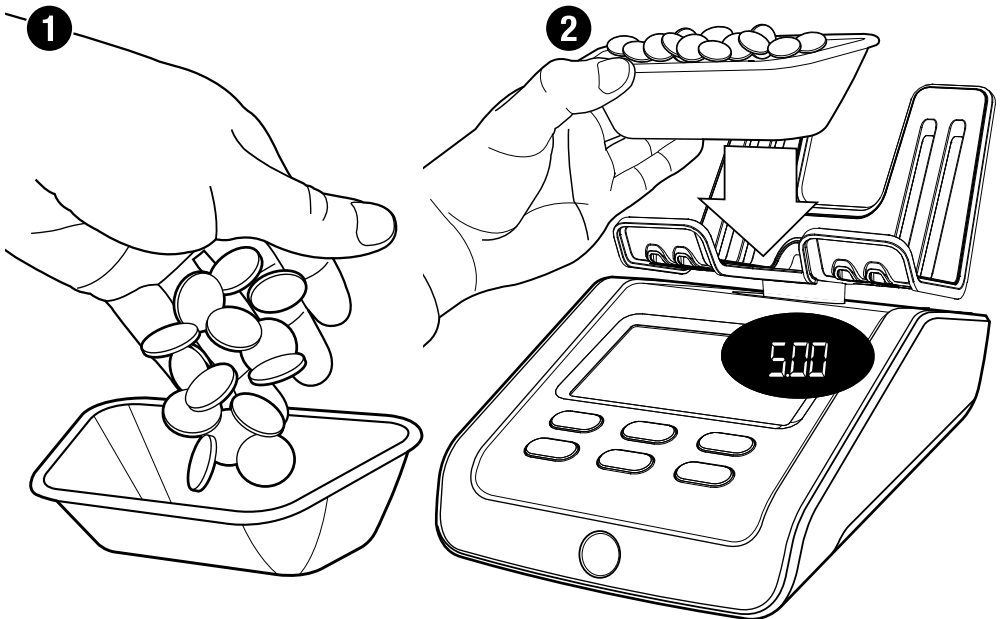

The device will show a denomination on the top right corner of the screen. Place the coins of the shown denomination in the coin cup.

Once all the coins are transported, place the coin cup on the money platform of the device.

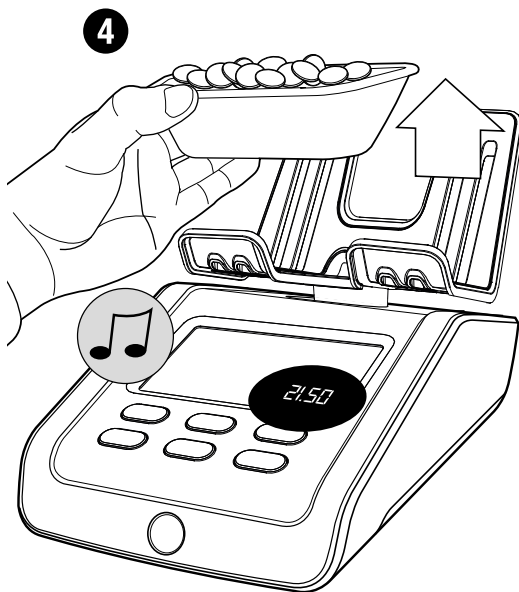

The quantity and value of the coins will be displayed. When the device has finished counting you will hear a beep to confirm.

Take the coin cup from the platform. The counting result will be added to the total, you will hear a beep to confirm.

The 6175 will automatically switch to the next coin denomination. Alternatively, use the (◀▶) buttons to select a denomination. After the highest value coin denomination has been counted, the 6175 will automatically switch to the lowest value banknote denomination.

5.2. Counting banknotes

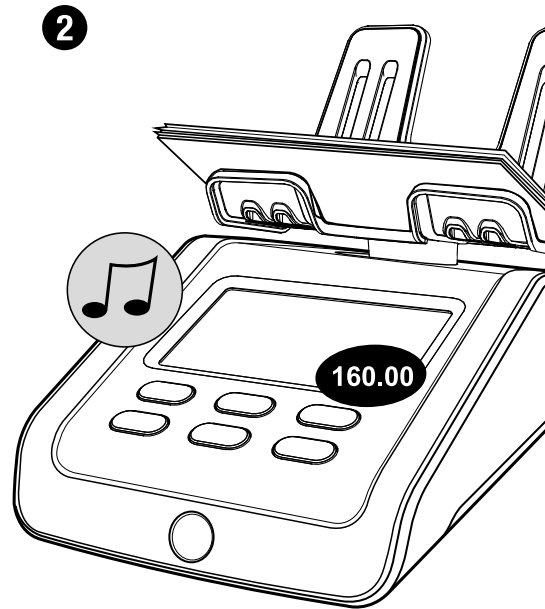
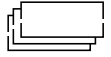

Once you have counted all the loose coins, the device will move on to banknotes. Starting with the denomination shown in the top right corner of the screen.

Place the banknotes of the shown denomination on the money platform of the device. Please do so in small batches of maximum 25 banknotes to ensure the most accurate count.

You will hear a beep to confirm that the banknotes have been counted. The display then shows the total number and value of banknotes and adds the value to the total.



Leave the first stack on the money platform and add the next stack of the same denomination. Continue adding stacks until all banknotes of the selected denomination have been counted.

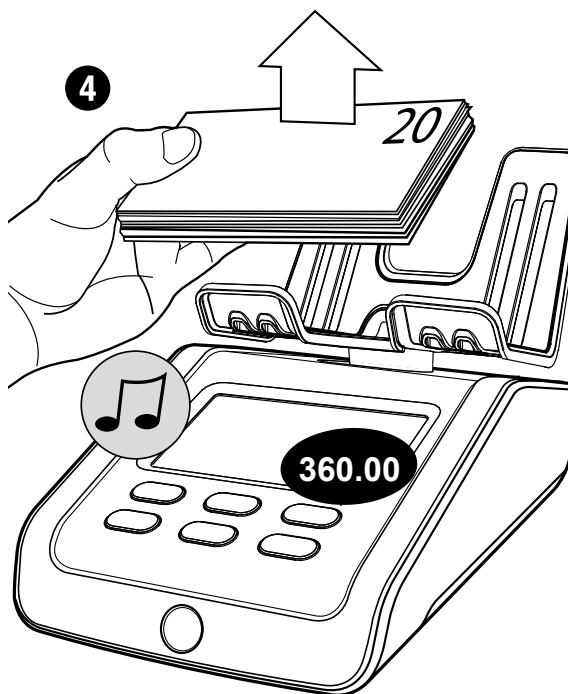

Remove all banknotes simultaneously from the platform. You will hear a beep to confirm that the banknotes have been counted. Their value will be added to the total. The 6175 will automatically switch to the next banknote denomination.

5.2.1. Too many banknotes on the platform



Too many banknotes have been placed on the platform. The display shows **“Remove ..-.. pcs”**. Remove as many banknotes as suggested until the 6175 has been able to determine the number of banknotes. Continue to add more banknotes on the platform in small batches.

5.2.2. Illogical weight detected



Illogical weight detected: the 6175 is not able to determine the correct number of banknotes on the platform. The display shows **“Remove Some”**. Remove a few banknotes (max. 5 notes at a time) until the 6175 has been able to determine the number of banknotes. Continue to add more banknotes on the platform in small batches.

5.3. Counting old and new versions of the same denomination

If the weight difference between an old and new banknote (denomination) version is within a certain limit, you can count them together. There is no need to sort them first. Please note that you can only count a maximum of 20 banknotes at once.

If the weight difference between the different versions is not within the limit, the Safescan 6175 may ask you to count them separately.

The versions are indicated on the display.

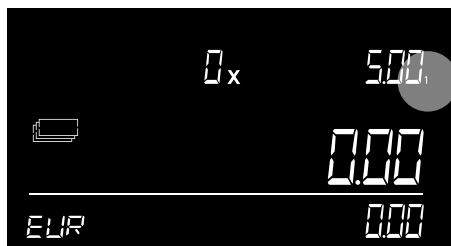

Version 1 is the old version

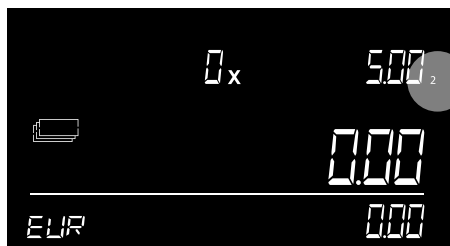

Version 2 is the new version.

Whenever a new version or denomination of a pre-installed currency is released, you can update the Safescan 6175 for free by downloading a currency update from **www.safescan.com**.

5.4. Counting coin rolls

Only place complete coin rolls on the money platform. This means that the coin roll contains the correct number of coins and that these coins are all from the same denomination and currency.

Coin roll weights of **EUR**, **GBP**, **USD** and **HKD** are pre-calibrated on the device. Coin roll weights for other currencies can be calibrated manually. Please see chapter 4.2.6. how to calibrate coin rolls.

5.4.1. Counting coin rolls/bags with automatic coin roll recognition 'AUTO'

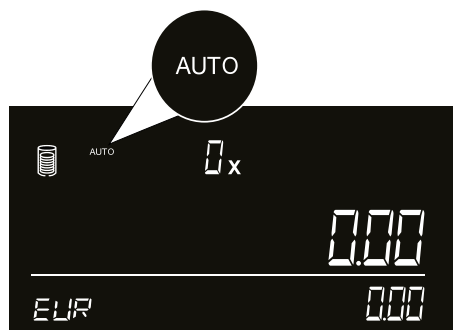

Automatic coin roll recognition will start directly after counting loose banknotes. In the screen the '**AUTO**' icon is shown.



Place one complete coin roll of the selected currency on the money platform.

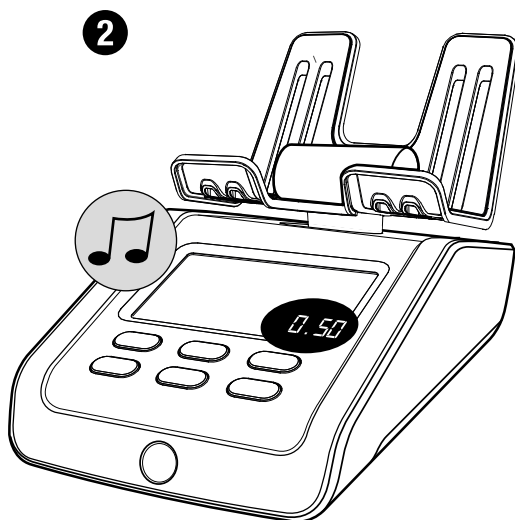

A beep sounds after confirming the coin roll. The quantity, value and roll-denomination will shortly be displayed (2 sec). After that, the total quantity and value of coin rolls will be shown.

3

+ 1 Roll
+ 1 Roll
+ 1 Roll



Add another coin roll on the platform and wait for the confirmation beep sound before you add the next coin roll. Repeat this process by adding coin rolls one by one until all coin rolls are on the platform and counted.

4



Remove all coin rolls from the money platform. The counting result will be added to the total.

Please note that the auto-roll feature is not available for HKD currency. Follow the procedure as described in 5.4.3.

5.4.2. Counting coin rolls / bags that are similar in weight

Some currencies have coin packages that are different in denomination but similar in weight. When such a package is detected, the Safescan 6175 will give you the opportunity to select the correct denomination. Please see an example below of how to operate this function.



1. The device has detected a denomination package with a common weight. The message **"SELECT"** is shown and the arrows are blinking.



2. Use the (◀ ▶) buttons to select the denomination of the coin roll/bag which is placed on the platform.



3. Press **"OK"** to confirm the coin roll/bag denomination. The device will add the counting results to the total.

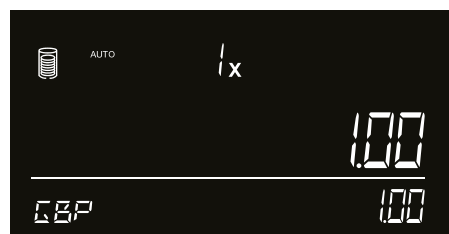

4. After 2 seconds the denomination indication disappears. The device is ready to receive a next coin roll/bag.

5.4.3. Counting & viewing coin rolls or bags per denomination

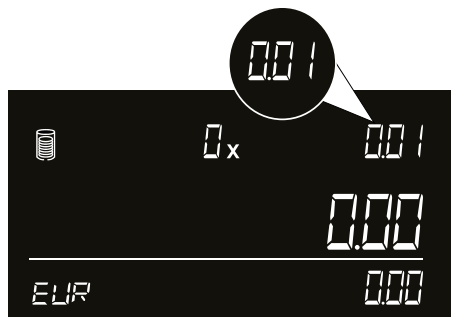
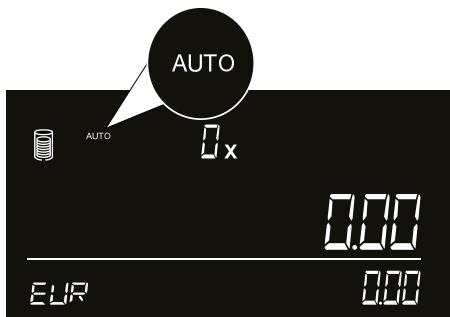

To count coin rolls per denomination, use (◀ ▶) buttons to select 'AUTO' coin rolls. Press "OK" .

Use the (▶) button to select the first available coin roll denomination.

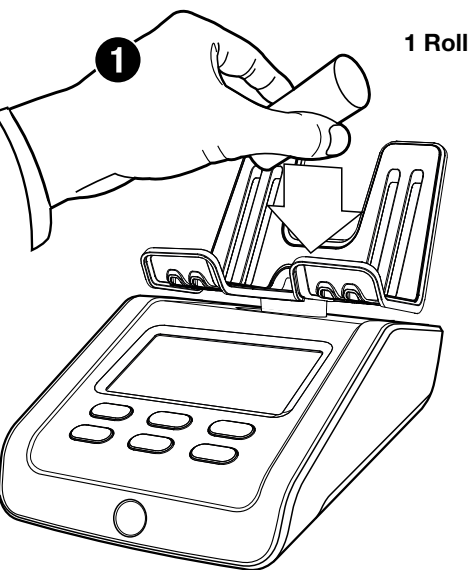

Place one complete coin roll of the selected denomination on the money platform.

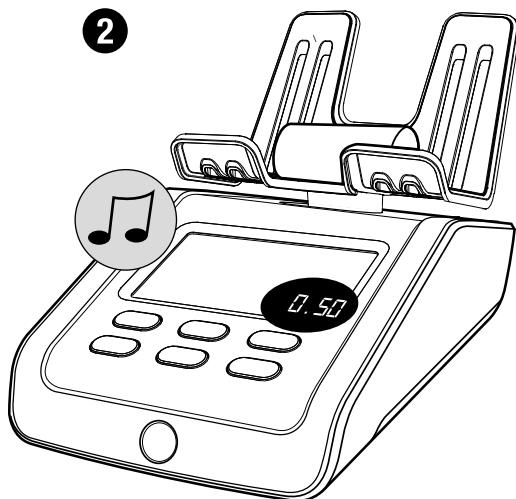

A beep sounds after confirming the coin roll. The quantity, value and roll-denomination is shown.

3

+ 1 Roll
+ 1 Roll
+ 1 Roll



Add another coin roll of the selected denomination on the platform and wait for the confirmation beep sound before you add the next coin roll. Repeat this process by adding coin rolls one by one until all coin rolls of this denomination are on the platform and counted.

4



Remove all coin rolls from the money platform. The counting result will be added to the total. The device will automatically switch to the next coin roll denomination.

5.5. Ending a count

5.5.1. View current count results

To view the counting results of the coin rolls, use the (◀▶) buttons to select '**AUTO**' coin rolls and press "**OK**" to view the separate coin roll results.

5.5.2. Clear / Correct count results

At any time during a count you can clear or add counting results to a count item. Simply toggle to the item which needs to be changed using the (◀▶) buttons. From this point you can:

- Add more of the selected count item to complete the counting.
 - Press "**CE**" to clear the count results of the selected count item.
- When you want to clear the complete count, start a new count as described in the **MENU** items.

5.5.3. Save / Print* / SET Bank / Add Reference

The Safescan 6175 has a convenient Count Menu that contains all necessary features to count your items and export your results.

Simply press "**OK**" during your count to access the Count Menu. Please consult chapter 7 for more information.

* Print count results

Once you have finished your count, you can print the counting results using the optional Safescan TP-230 printer.

5.5.4. Export count results to Safescan MCS

Connect the Safescan 6175 to your computer to export your counting results. Start the Safescan Money Counting Software. When performing a single count, click on the “Live Count” icon to view the current count and then press “accept” to save the count result. When you have saved one or more counts in the 6175’s memory, click on the Count Data icon to download these count results from the Safescan 6175 to your computer. Please consult the Safescan MCS Software manual for more information. You can download the manual from **www.safescan.com**.

5.5.5. Start a new count

To start a new count, press “**MENU**”. The display will show “**NEW COUNT**”. Press “**OK**” to confirm.

6. Menu's and operation

This chapter contains operational instructions and explains the different menu structures of the Safescan 6175.

6.1. General operation

When a certain action is required or when several options are possible, the (◀▶) buttons can be used to navigate. When navigation is possible or when a choice has to be made in the menu, the screen will show 2 blinking arrows. For example:

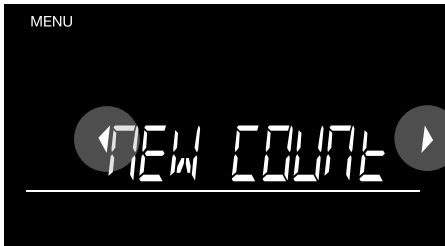

The 2 blinking arrows indicate that you can navigate between available menu items



The 2 blinking arrows indicate that you have to select a number.

A selection can be confirmed by pressing the “OK” button. To go back to the previous step, press the “CE” button.

6.2. Menu structure

You can enter the device menu by pressing the **“MENU”** button. To navigate through the items, use the (◀▶) buttons. To enter a option, press **“OK”**. The structure of the menu is as follows:

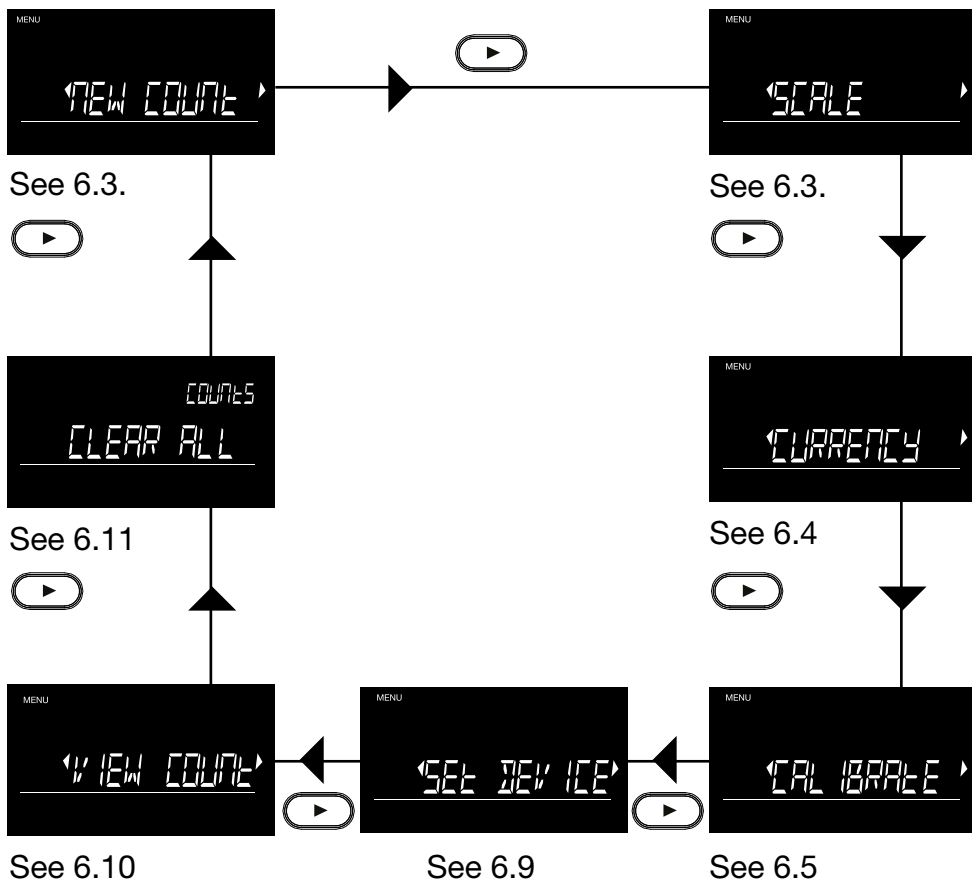

6.3. New count



When you want to start a new count and erase all existing results, press “OK” when the “NEW COUNT” screen is shown.

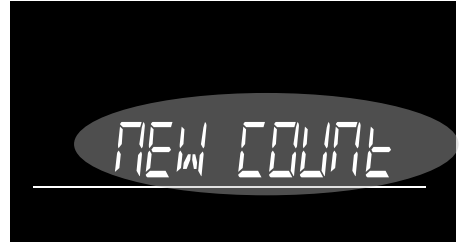

The text will start blinking. Press “OK” again to confirm.

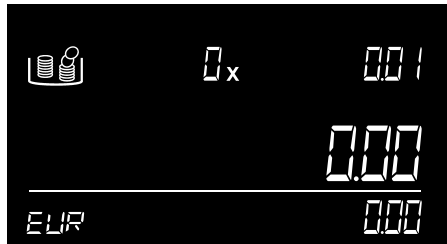

The machine will go back to the count screen, which is fully set back to zero.

6.4. Weighing scale



To activate the weighing scale function, press **“OK”** .



The screen will now change to weighing mode.



You can now weigh items with an accuracy of 0.05 gram.

You can tare the weighing scale by pressing **“OK”** when the default item, like a cup, has been placed. A **“*”** will show in the screen and the value will change back to zero. Once the default item is removed, it's weight will show as a negative value.

6.5. Currency

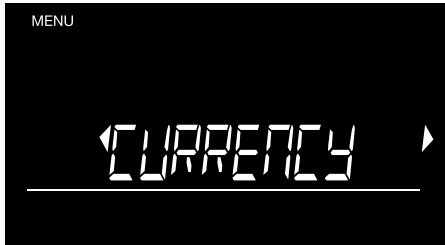

When you want to change the currency, press **“OK”** when the **“CURRENCY”** screen is shown.

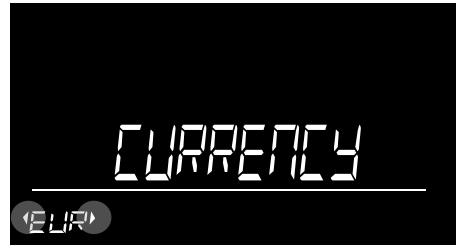

The active currency is now shown, with 2 blinking arrows. Use (◀ ▶) to navigate to the desired currency.

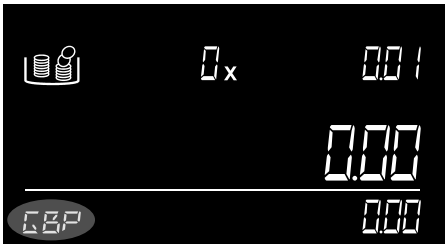

After pressing **“OK”**, the machine will now go back to the count screen, showing the chosen currency.

6.6. Calibrating coin rolls, coin bags, banknote bundles, non-cash items or a second coin cup



Besides loose coins and banknotes, the Safescan 6175 can also count coin rolls, coin bags, banknote bundles, non-cash items and recognise a second coin cup. However, these items must be calibrated first. To enter the calibration mode, press **“OK”** when the **“CALIBRATE”** screen is shown. When in calibration mode, use the (◀▶) buttons to navigate to the desired denomination. If you want to switch to the next calibration item, press **“MENU”**. The sequence is Coin Rolls - Banknote Bundles - Vouchers - Tokens - 2nd Coin Cup.

The calibration process for each bundled item coin rolls, coin bags and banknote bundles is the same, and goes as follows:

Calibrate coin rolls/bags and banknote bundles

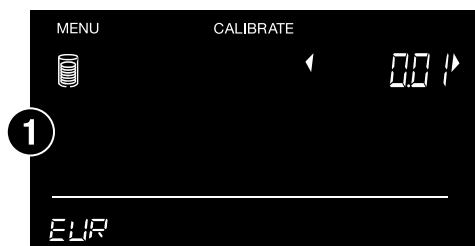

Example: For coin rolls. Move to the desired denomination with (◀▶) and confirm by pressing **“OK”**.



Now place 5 empty coin rolls (of that denomination) on the platform.



The machine will now ask you to confirm. Press **“OK”** to do so.



Remove the coin rolls to go to the next calibration step.



Select the number of coins that the rolls will contain by using the (◀▶) buttons and press **“OK”**.



Press **“OK”** to save. The roll has now been calibrated and is saved in the machine.

The calibration menu will now move to the next denomination. Repeat the process by selecting the desired denomination as shown above, or leave the calibration mode by pressing **“OK”**. If you want to switch to the next calibration item, use the **“MENU”** button.

6.7. Calibrating non-cash items

The Safescan 6175 can also count non-cash item such as vouchers, coupons, token and chips. Follow the instructions below to calibrate these items and make them available in the count menu.

6.7.1. Calibrating vouchers

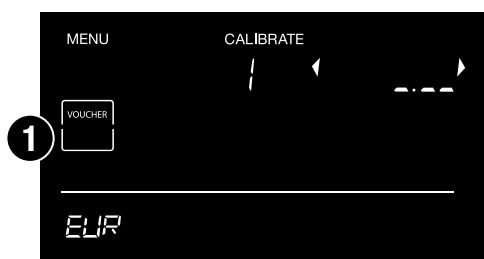

Use the (◀▶) / (MENU) buttons to navigate to 'vouchers' and press "OK".

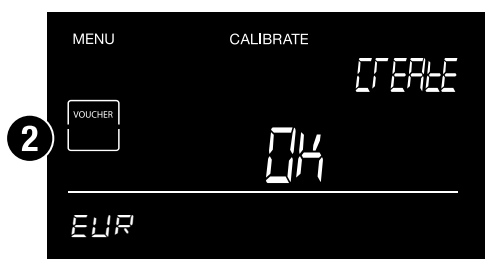

Press "OK" again to confirm the calibration of the voucher.



Use the (◀▶) buttons to set a number for the first digit. For example "2". Press "OK" to use the number. The next digit will start to blink.

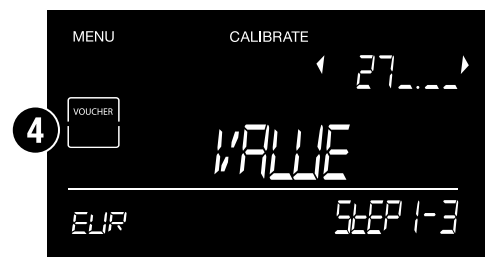

Use the (◀▶) buttons to set a number for the next digit. For example "7". Press "OK" to use the number. The next digit will start to blink.



Use the (◀ ▶) buttons to set a number for the next digit. For example “5”. Press “OK” to use the number. The next digit will start to blink.

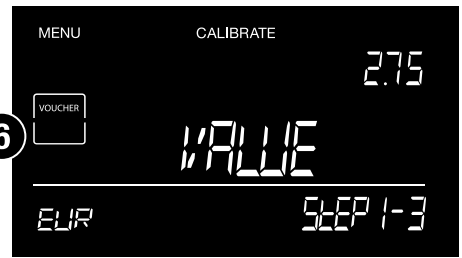

For example: The value of the voucher is: **2.75**

Press “OK” to confirm. The entry of 275 will be automatically converted to the value: 2.75 (with “.75” as decimals).



Place 10 vouchers on the platform. After weighing the vouchers the device will sound a beep. Press “OK” to confirm.

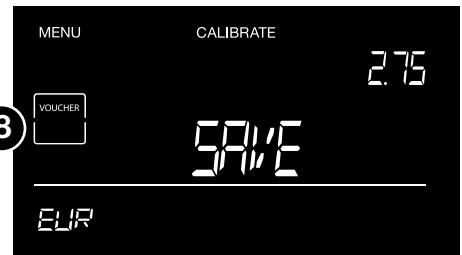

Press “OK” to save the voucher settings. The device will automatically switch to the next voucher for calibration. Press “OK” to calibrate the next voucher or press “CE” to exit the calibration menu.

6.7.2. Calibrating tokens

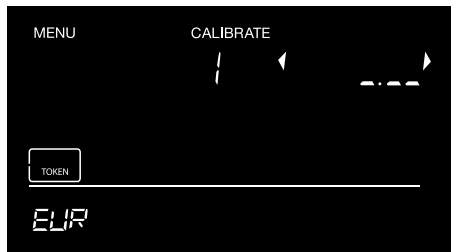

Use the (◀▶) / (MENU) buttons to navigate to 'tokens' and press **"OK"**.

The procedure is the same as calibrating vouchers as described in the previous chapter.

There are two differences compared to the calibration of vouchers:

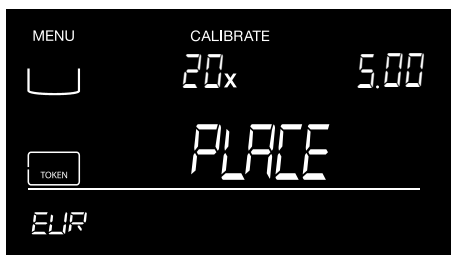

1. The device will ask you to place 20 tokens on it.
2. To weight the tokens, you must use the included coin cup. This means that you must put the 20 tokens in the coin cup before placing it on the device.

6.8. Calibrating a second coin cup

The Safescan 6175 automatically recognises coin cups with a standard weight of 33.5 grams. If your cash drawer contains cups with a different weight, you can configure the Safescan 6175 to recognise them.

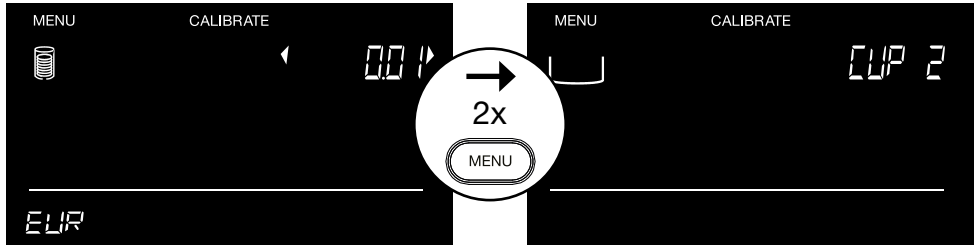

When pressing “OK”, you will be prompted to place the cup.



The machine will show that the cup weight has been processed.



Press “OK” to confirm the calibration.



The cup has now been calibrated.

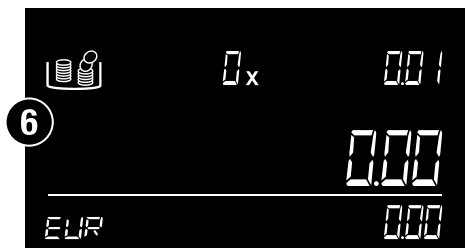
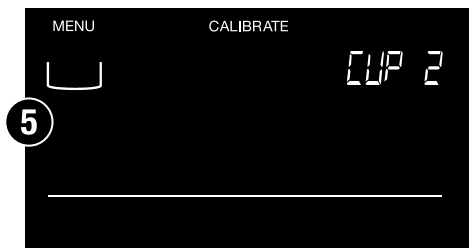

Press “**OK**” to return to the count screen.

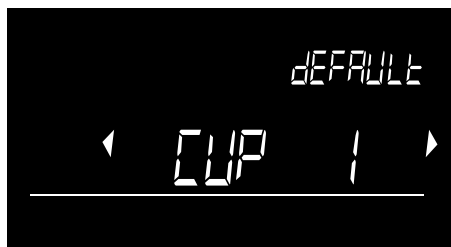

From now on, once you start up the Safescan 6175, you will be asked to confirm which cup has to be set as preference: the cup that comes with the device as a default (CUP 1) or the cup that was calibrated (CUP 2). Use the (◀ ▶) buttons to select the cup you want to set as preferred. The selection will be saved automatically.

6.9. Set device

The Safescan 6175 automatically recognises coin cups with a standard weight of 33.5 grams. If your cash drawer contains cups with a different weight, you can configure the Safescan 6175 to recognise them. Press “OK” to enter this menu item. When in the “**SET DEVICE**” mode, use the (◀ ▶) buttons to navigate through the sub-items.



6.9.1. Submenu - structure

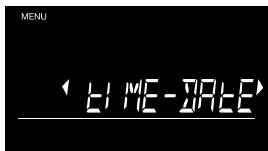

See 6.9.2 - A



See 6.9.2 - B

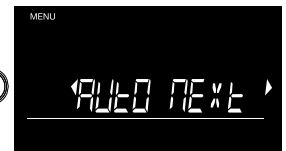

See 6.9.2 - C



See 6.9.2 - D



See 6.9.2 - E



See 6.9.2 - F



See 6.9.2 - G



See 6.9.2 - H

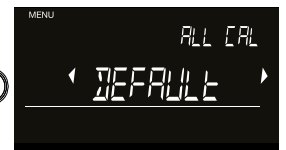

See 6.9.2 - I

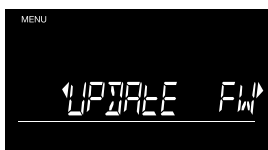

See 6.9.2 - J

6.9.2. Time and date setting

A. Time and date setting

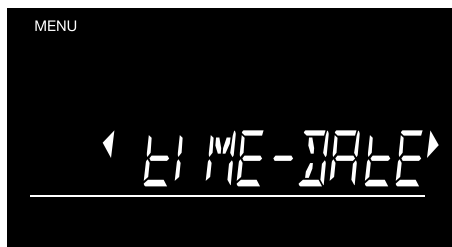

Press **“OK”** to start the **”TIME-DATE”** setting process.

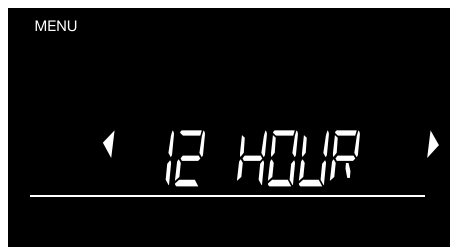

Switch between 12 hour and 24 hour format by using (◀ ▶), and press **“OK”** to confirm.

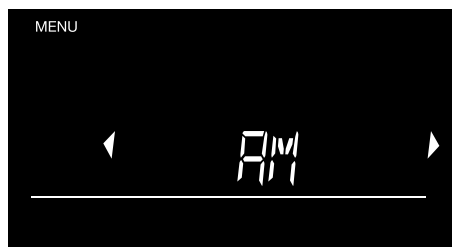

Switch between AM and PM by using (◀ ▶), and press **“OK”** to confirm.

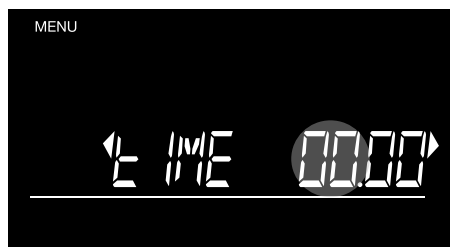

The hours now start blinking. Short press (◀ ▶) to go 1 hour up or down or press and hold to run through the hours. Press **“OK”** to confirm.



The minutes now start blinking. Short press(◀▶) to go 1 minute up or down or press and hold to run through the minutes. Press “OK” to confirm.

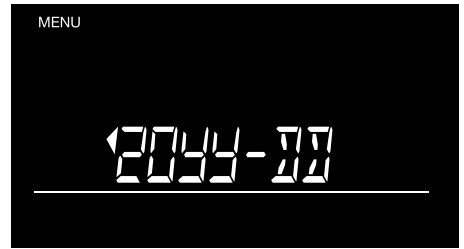

Navigate through the date formats by using (◀▶). Press “OK” to confirm the desired format. Now set year, month and day in the same way.



A short preview of the set time and date will be shown. The 6175 then returns to the submenu.

B. AUTO ADD

By activating the **AUTO ADD** function, the Safescan 6175 will automatically add the quantity and value of the counted denomination to the total results when the denomination is removed from the platform. The **AUTO ADD** function is always turned on by default. When you deactivate this function, you have to press the **"OK"** button to add the denomination results to the totals.



To activate or deactivate the function, press **"OK"** when the **AUTO ADD** screen is shown.



Switch between **ON** and **OFF** by using (◀ ▶) and press **"OK"** to confirm.

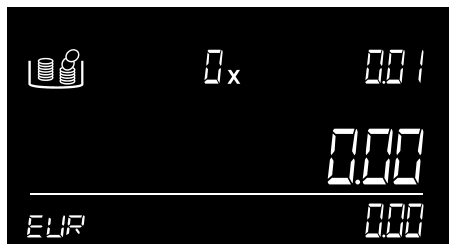

The device will go back to the count screen.

C. AUTO NEXT

By activating the **AUTO NEXT** function, the machine automatically switches to the next denomination once the items are removed from the platform. When this function is switched off, you have to use (▶) to move to the next denomination. By default the Auto Next setting is **ON**.



To activate or deactivate the function, press “OK” when the **AUTO NEXT** screen is shown.



Switch between **ON** and **OFF** by using (◀▶) and press “OK” to confirm.

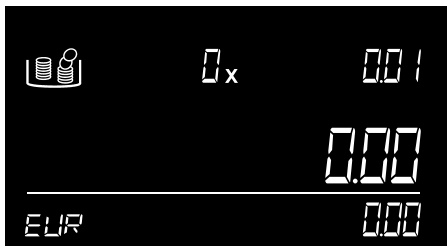

The device will go back to the count screen.

D. AUTO BANK

When activating the **AUTO BANK** feature, the Safescan 6175 will ask you to set your bank amount at the start of each new count.



To activate or deactivate the function, press “OK” when the **AUTO ADD** screen is shown.



Switch between **ON** and **OFF** by using (◀ ▶) and press “OK” to confirm.

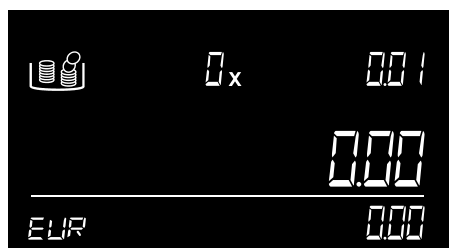

The device will proceed to the count screen.

E. AUTO REF

When activating the **AUTO REF** feature, the Safescan 6175 will ask you to insert a reference number at the start of each new count.



To activate or deactivate the function, press “OK” when the **AUTO ADD** screen is shown.



Switch between **ON** and **OFF** by using (◀ ▶) and press “OK” to confirm.

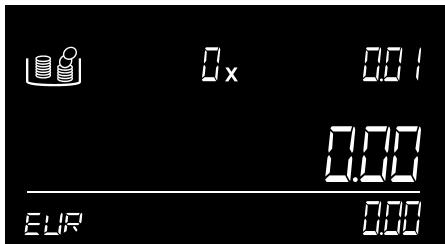

The device will proceed to the count screen.

F. Recalibrate load cell



If (due to an overload or heavy impact) the load cell / weighing element of the Safescan 6175 is damaged, it might be necessary to recalibrate it.

1. Press “**OK**” to start the recalibration process.
2. The device will start ‘taring’ and will proceed to ask to place a 500 gram weight* on the platform.
3. After placing the 500 gram weight the device will automatically start the calibration process. In the screen the text: “Sampling” is blinking.
4. When the process is done the device will display: Finished. Please remove the weight from the money platform. The device is now ready for usage.

* You can purchase a calibration weight of 500 grams on www.safescan.com. If you cannot find it on the website, please contact us.

G. Region setting



Select the region where you will be using your Safescan 6175. Use the (◀▶) buttons to toggle between “**EUROPE**”, “**UK**”, “**USA**”, “**S-E ASIA**” and “**AUSTRALIA**”. Press “**OK**” to confirm.

H & I. Back to factory default setting

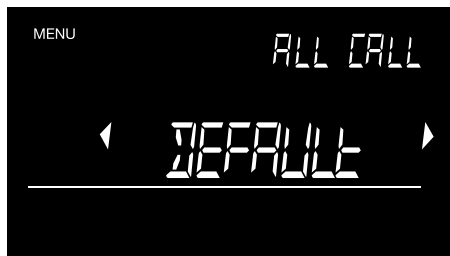

Press “**OK**” to start resetting the machine. If you want to start fresh with your Safescan 6175, you can reset the device back to its default factory settings. Default: Reset to default settings while keeping user calibrations of coin packages. Default ‘**All Cal**’: Reset to default settings including user calibrations and coin packages.

WARNING: By selecting the Default ‘**ALL CAL**’ reset option, all customized settings such as calibrated items will be deleted and all basic settings will apply from the restart.

To reload the pre-configured coin roll data for **EUR, GBP, USD** and **HKD**, please run the Currency Update Tool and select “**Yes**” when the pop-up appears that asks you if you want to include pre-configured coin roll data on your device. Then press “**Save to device**” to save this data again to your Safescan money counting scale.

J. Update firmware



Press “**OK**” to set the device in firmware-update mode. Firmware updates (when applicable) are available via www.safescan.com. Download the firmware update package and follow the included instructions to update your Safescan 6175.

6.10. View saved count results



To view the saved counting results press “**OK**”.

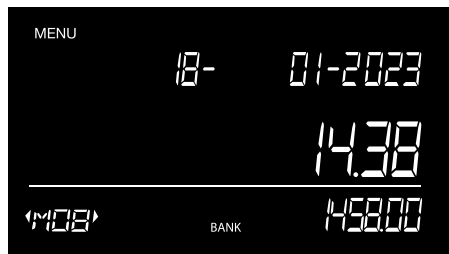

The count number (M#) of the last saved count will start blinking. Use the arrow keys (◀▶) to navigate to the desired count number and press “**OK**” to view the results.

- Use the arrow keys (◀▶) to view the count results.
- Use the “**CE**” button to go to a previous step.
- Press “**OK**” to print the selected count results.

6.11. Clear all counts



To open the **CLEAR ALL** feature, press “OK”.



The **CLEAR ALL** text will start blinking. Press “OK” to clear all counting results from the device.

7. Count menu and operation

The count menu contains all features that are useful during and after the count. In this menu you can:

- Save results
- Add a reference number to a count
- Set a bank value
- Print results

7.1. Opening the count menu

Press **“OK”** to open the count menu.

- The count menu can be accessed at all times during a count.
- The count menu can only be opened with an empty money platform.

After pressing **“OK”** the first feature **“SAVE COUNT”** will be shown.

Use the (◀ ▶) keys to navigate through the different features and press **“OK”** to select one.



If the two arrow keys are blinking, you are able to navigate between the available menu items.

7.2. Count menu structure

Use the (◀▶) keys to navigate between the different features and press "OK" to select one. The menu structure works as follows:

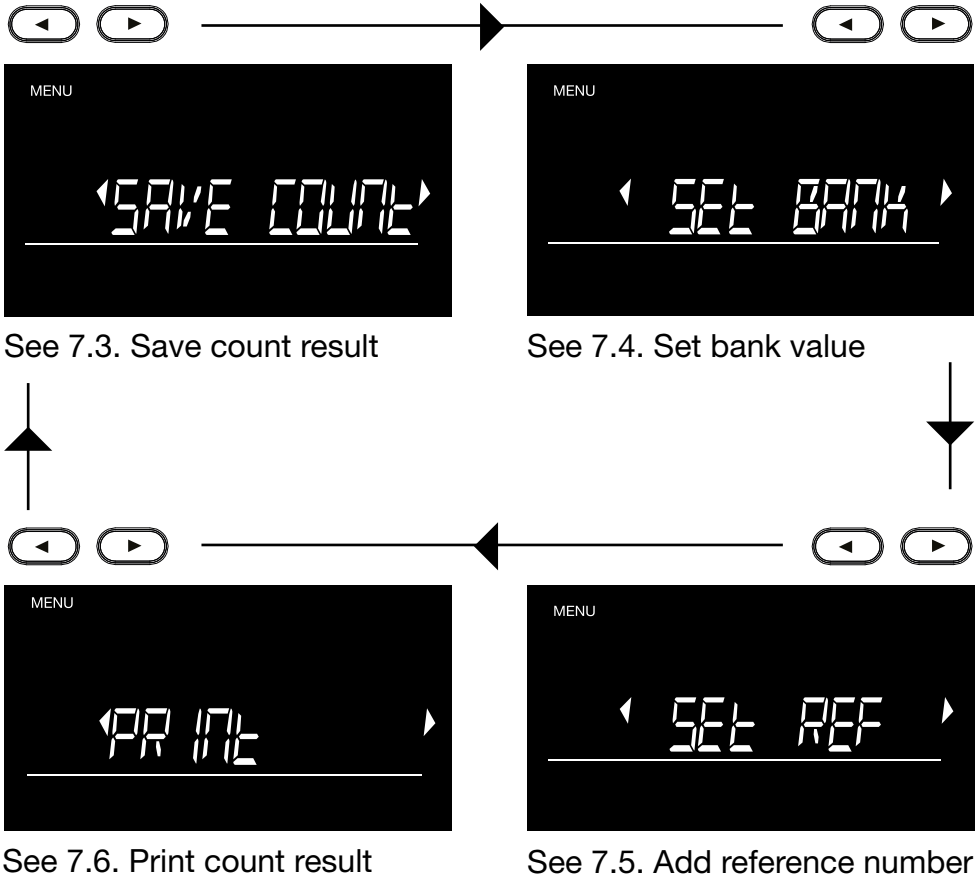

7.3. Save count

You can save your counting results on the internal memory of the device with the **“SAVE COUNT”** feature. You can then process them whenever this is convenient.



Press **“OK”** to save the counting results.

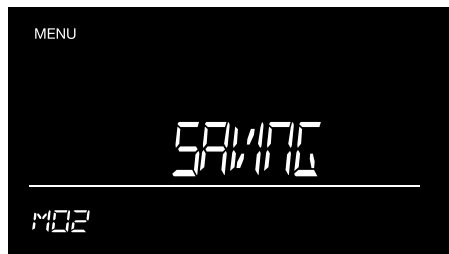

The counting result is now saved on the device. The linked memory number is displayed in the bottom left corner.

After saving the count result the device will go back to the count screen. If you want to use another feature(s) of the count menu, then press **“OK”** again to open the count menu.

7.4. Set bank

You can insert the start value of your cash drawer using the **“SET BANK”** option.



Press **“OK”** to select the bank feature and insert the start value of your cash drawer.

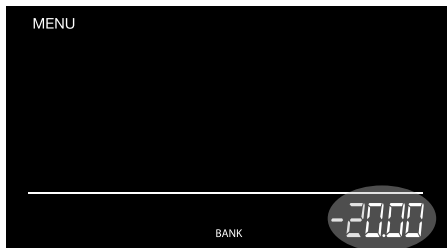

OR

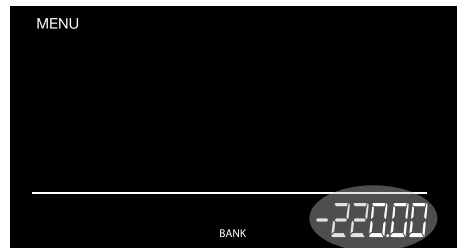

Use the (◀▶) keys to insert your bank value and press **“OK”** to confirm.

Press and hold the (◀▶) keys to enter larger bank values. The number will go up automatically. Press **“OK”** to confirm.

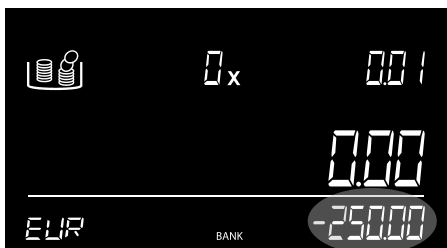

The bank value will now be shown as a negative start result which will be deducted from your total count.

After setting the bank value the device will go back to the count screen. If you want to use another feature(s) of the count menu, then press **“OK”** again to open the count menu.

7.5. Set a reference number

The reference feature allows you to link a reference number to your counting results. This number can be linked to a specific cash drawer or employee.

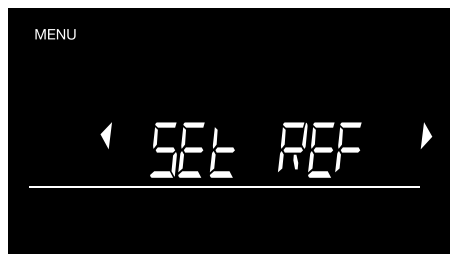

Press **“OK”** to set a reference number.

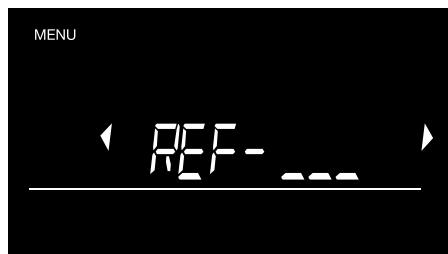

Use the (◀ ▶) buttons to set a number for the first digit. Press **“OK”** to confirm the number. The second digit will now start to blink.

Press **“OK”** again to confirm the reference number that you set or use the (◀ ▶) keys and repeat the first step to set the second and third digits.

NOTE:

Previously set-up reference numbers will be shown when opening the **SET REF** feature. Use the (◀ ▶) keys to go through the different numbers and press **“OK”** to use it.

Press **“CE”** to enter a new reference code.

After adding a reference, the device will go back to the count screen. If you want to use another feature(s) of the count menu, then press **“OK”** again to open the count menu.

7.6. Print



To print your counting results, first connect your Safescan TP-230 printer and press **"OK"**.

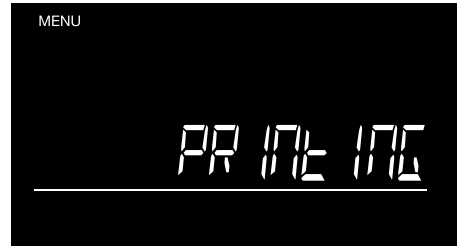

The notification **"PRINTING"** will be displayed while the Safescan TP-230 is printing.

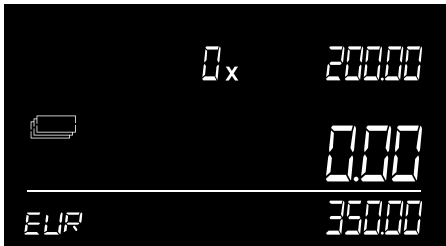

The device will go back to the count screen once the printer is done. If you want to use another feature(s) of the count menu, then press **"OK"**. again to open the count menu.

8. Troubleshooting

This chapter describes the operation of the Safescan 6175, as well as the menu structure of the device.

Error message



Description

SUSPECT - CHECK ITEM

Incorrect number of coins detected in a coin roll / incorrect number of banknotes detected in a banknote bundle.



Solution:

Check the coin roll / banknote bundle for any missing or excess coins / notes. Correct this and count again. Due to the high weight tolerance of banknotes, the 6175 is not able to detect incomplete banknote bundles.



REMOVE ALL

There are still items present on the platform after "OK" has been pressed - or the money platform was not empty during taring.

Error message

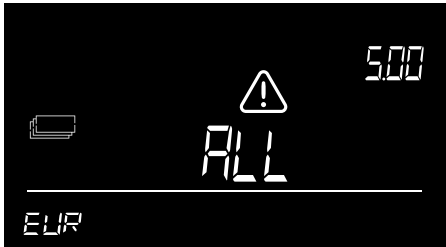

Description

Solution:

Clear the platform of all items before pressing “OK” or entering a new command. Ensure there are no objects on the platform while the 6175 tares itself.

Counted quantity is not correct

Counted quantity is not correct.

Check if the coin cup was already placed on the device during start up. In that case the weight of the cup is automatically tared which will cause an incorrect count (valid for coins only). Check if the money platform has been removed and placed during counting

Solution:

- Remove the cup from the platform and place it on the platform again, or restart the device. Make sure the cup is not on the platform when powering on the 6175.
- Never (re)move the money platform during counting

Error message



Description

OVERLOAD

Too much weight has been placed on the money platform

Solution:

Remove all weight from the platform. If the message disappears: continue using your 6175 as normal. If the message remains: switch off the 6175 and switch it back on. If the message appears frequently or doesn't go away, contact the Safescan Customer Success Team.



MEMORY FULL

The memory for saving count results is full.

Solution:

1. Press "**MENU**" and use the (◀▶) buttons to go the Clear all counts results. (see chapter 6.11.)
2. Connect the 6175 to the MCS and download the count results in the tab: "**COUNT DATA**". to your PC.

Error message



Description

Remove .. - .. PCS

The weight on the scale is too high for the 6175 to determine the exact number of coins or banknotes.

Solution:

Remove as many coins or banknotes from the money platform as indicated, until the 6175 has been able to determine the number. Continue counting. Banknotes should always be placed on the platform in stacks of max. 25 pcs at a time. The counting of 2 versions of the same denomination is possible when:

The first stack of banknotes on the money platform does not exceed 10 pcs.

The subsequent stacks of banknotes do not exceed 15 pcs.

Error message



Description

REMOVE SOME

Valid for banknote counting only. The weight on the scale is illogical. Caused by the weight tolerance of the banknote - the 6175 can not determine the exact number of banknotes on the platform.

Solution:

Remove a small number of banknotes until the 6175 has been able to determine the number. Continue counting. Banknotes should always be placed on the platform in stacks of max. 25 pcs at a time. The counting of 2 versions of the same denomination is possible when:

The first stack of banknotes on the money platform does not exceed 10 pcs.

The subsequent stacks of banknotes do not exceed 15 pcs.

Error message



Description

BATTERY LOW

Battery power is lower than 5%.



Solution:

Connect the power adapter to recharge the battery. This message can only appear when the Safescan LB-205 battery is inserted.



DEFECT

The loadcell is defect, no weighing / counting possible.

Solution:

Contact the Safescan Customer Success Team

9. Rechargeable battery (Optional accessory)

9.1. Installing the Safescan LB-205 rechargeable battery

1. Disconnect the power adapter.
2. Remove the money platform from the scale.
3. Turn the device upside down and open the battery lid (see chapter 3.1).
4. Place the battery in the battery compartment, connect the wire and close the lid.
5. Place the money platform on the scale.
6. Connect the power adapter to charge the battery.

9.2. Rechargeable battery status indication

- At start up: Inner segments are blinking for 5 seconds -> Battery is being charged.
- At start up: All segments are blinking for 5 seconds after this the battery icon remains on -> Battery is 100% charged.



- Device is powered by the battery only:
- Full battery is on -> Battery power is 100%



- Half the battery indicator is filled* -> Battery power more than 50%
- Half the battery is blinking continuously -> Battery power less than 20%



- Empty battery indicator is blinking* -> Battery is empty (battery power less than 5%)
In the screen the message Battery Low will be blinking, connect the power adapter to recharge the battery.

Note: battery life may decrease after many load cycles - this is common when using rechargeable batteries.

10. Updates

For more information about device and currency updates see **www.safescan.com** for details.

Firmware updates are loaded to the device via the Update FW option in the menu, see 6.9.2 - J.

Weight table updates are done via the free currency update software tool. This software will automatically check for firmware updates and load the latest weight table file to your 6175.

Update instructions can be found within the update package, which can be downloaded from **www.safescan.com**.

11. Safety precautions

Safescan 6175

WARNING! Failure to follow these precautions can lead to short-circuits and serious injuries such as burns, electrical shocks and fire hazards.



- Never use a damaged power adapter/power cord.
- Always and only use the supplied power adapter.
- Never subject the device, power adapter or cords to liquids or moisture, or touch them with wet hands.
- Never touch and (dis)connect the power adapter with wet hands.
- Always unplug the device from the mains socket if you want to move it to another position.
- Always hold the plug when unplugging the device from the mains socket, never pull the cord.
- Never spill any liquids or chemical (cleaning) detergents on the device.
- If liquids are spilled on the device, always disconnect the power from the mains supply socket, remove the battery (when installed) and contact Safescan for assistance.

CAUTION! Damage of product or weighing element



- Please ensure that no foreign objects (coins, paper clips, staples,) fall into the machine, these may block the mechanical parts and or weighing element of the machine and damage or break them and will void your warranty.
- Always place the 6175 on a flat and stable surface and keep the area around the money platform clear.
- To avoid damaging the device or any malfunctions, clean the device with a dry cloth. Do not use a wet or damp cloth or (chemical) cleaning products.

NOTICE! Risk of malfunctioning or damaging the device



- As with any precision weighing scale, the weighing result is influenced by substantial airflow. Therefore, do not use the device near cooling fans, air conditioners, open windows etc.
- Carefully place items on the weighing platform, do not throw or drop them.
- Do not drop, hit or shake the 6175.
- Never place items weighing more than 1.5 kg on the 6175.
- The Safescan 6175 cannot identify counterfeit money.
- Never disassemble the device, this will immediately void your warranty.
- Never leave any items - not even the coin cup - on the money platform when the device is not in use or when it is stored for a longer period.
- Do not use the machine in dusty or dirty environments, as this can lead to sensor malfunctioning.
- If the machine is not used for a long period of time, remove the power plug from the wall outlet, to avoid possible damage of the equipment.
- To avoid damaging the device. Only use the optionally available Safescan LB-205 rechargeable battery.

BATTERY LB-205 (optional product)

WARNING! Burns, fire hazard and poisoning.

Risk of serious injury



- Always keep batteries away from fire, heat and water.
- Always avoid touching the battery with your bare hands when battery is corroded or when leakage has occurred.

CAUTION! Damage, leakage



- Always remove the battery from the device in case of long term non-use or storage.
- To avoid pollution, dispose of batteries in accordance with local regulations.

12. Optional accessories

Rechargeable battery

Safescan LB-205 battery

Thermal receipt printer

Safescan TP-230

Money Counting Software

Safescan MCS

Weighable coin cup set

Safescan 4141CC

Safescan 4617CC

13. Specifications

Features

- Money Counting Scale for counting coins, banknotes, banknote bundles and coin rolls.
- Save counting results to memory
- Add a reference number to a count
- Can also be used as precision weighing scale (note: not “approved legal for trade”).

Currencies

Depends on region - see www.safescan.com for more information

Dimensions (LxWxH) 22.3 x 14.2 x 14.7 cm / 8.8 x 5.6 x 5.8 inch

Display 4.1 inch high contrast LCD

Interface USB-B to PC, RJ-10 to printer

Power requirements Power supply 12V/0.5A

Power consumption

Max. 2.4W in operating mode (no battery charging)

Max. 6W in operating mode (including battery charging)

Max 50mW in stand by/idle mode

Operating temperature 0 - 40°C

Storage temperature -25 ~ 55°C

Maximum load capacity 1.5 kg / 3.3 lbs

Maximum precision 0.05 gr

Net Weight 660 gr / 23 oz

Certification CE, FCC, RoHS

Safescan®

Safescan B.V.
PO Box 7067, 2701AB Zoetermeer, NL
Designed in Europe - Made in China
www.safescan.com
© 2023 Safescan. All rights reserved
SAFESCAN® is a registered trademark

www.safescan.com

20231